



**Grant Agreement no. 226967**  
**Seismic Hazard Harmonization in Europe**  
**Project Acronym: SHARE**

**SP 1-Cooperation**

**Collaborative project: Small or medium-scale focused research project**

**THEME 6: Environment**

**Call: ENV.2008.1.3.1.1 Development of a common methodology and tools to evaluate earthquake hazard in Europe**

**D3.4 – Database of active faults and seismogenic sources**

**Due date of deliverable: 31.05.2011**

**Actual submission date: 31.05.2011**

Start date of project: 2009-06-01

Duration: 36

**Istituto Nazionale di Geofisica e Vulcanologia (INGV)**

**ROBERTO BASILI, VANJA KASTELIC**

Revision: 1

<b>Dissemination Level</b>		
<b>PU</b>	Public	<b>X</b>
<b>PP</b>	Restricted to other programme participants (including the Commission Services)	
<b>RE</b>	Restricted to a group specified by the consortium (including the Commission Services)	
<b>CO</b>	Confidential, only for members of the consortium (including the Commission Services)	

## Summary

1. Introduction	1
2. Basic definitions and database rationale	3
2.1. Seismogenic sources	3
2.2. Database structure	5
2.3. Data collection strategy	10
3. Regional databases of crustal seismogenic sources	13
4. Merged database of crustal seismogenic sources	15
5. Subductions	17
6. From the database to the actual input data	20
7. References	24

## List of figures

Figure 1. Generalized three-dimensional representation of a seismogenic source as idealized in many models. Bold gray line is the top edge of the source and shaded dipping surface represents the seismogenic source. The bold black arrow on the fault surface represents the direction of slip.....	3
Figure 2. Database general scheme: NA, Northern Africa; IB, Iberia; CM, Central Mediterranean; CE, Central Europe; EE, Eastern Europe; GR, Greece; TR, Turkey; SH, SHARE.....	6
Figure 3. Screen shot of the database web site. Only the upper part of the data access page is shown.....	7
Figure 4. Map of the regional subdivision of the SHARE area for collecting data about seismogenic sources.....	14
Figure 5. Maps showing the Composite Seismogenic Sources of the merged database. In the lower panel seismogenic sources are color coded according to faulting mechanism: Red = normal; blue = reverse; green = strike slip and oblique slip. ....	16
Figure 6. Map showing the main subduction zones. Color coding according to depth: blue = 0-10 km, light blue = 10-50 km, lime green = 50-200 km, orange = 200-300 km, red >300 km. ....	18
Figure 7. Map showing a sample output of the procedure that recalculates magnitudes.....	21
Figure 8. Map showing the fault sources background zones. Fault color codes as in Figure 5.....	22

# 1. Introduction

The goal of Task 3.2 was to compile a database of seismogenic sources of the Euro-Mediterranean area along the lines defined in the Description of Work reported below.

*“The Database of individual Seismogenic Sources, compiled by INGV (DISS, first released in 2000: DISS Working Group, 2007, <http://www.ingv.it/DISS/>) and its extension to S. Europe compiled within the EC-funded project FAUST and released in 2001-2002 ([http://legacy.ingv.it/~roma/banche/catalogo\\_europeo/](http://legacy.ingv.it/~roma/banche/catalogo_europeo/)) will be expanded to the larger Euro-Mediterranean area. Building on previous experiences in this field, common standards for the definition and characterization of active faults and active seismogenic sources will be adopted and consensus will be built by frequent exchanges and through regional meetings. Particular attention will be devoted to Quality Assurance and the characterization of uncertainties and of multiple interpretations, to ensure a homogenous input for use in hazard assessment. The European database of active faults and seismogenic sources, to be used by all project partners and open to all users, will be compiled and maintained by INGV.”*

This goal was tackled by collecting data about the geology and active tectonics of an area stretching along and away from the main plate tectonic boundary between Europe and Africa, from west of the Gibraltar Straits to the easternmost part of Anatolia and from the Atlas to the south and the Lower Rhine Embayment to the north. The cumulative length of all documented faults exceeds 66,000 kilometers. The data model for this collection has been adopted from the scheme designed in Italy in the previous decade summarized by Basili et al., 2008 and by taking into account the experience gained in other efforts of this kind, such as that of the USGS (Petersen et al., 2008) and the New Zealand (Stirling et al., 2002) fault databases.

The study area was subdivided into seven regions. A number of meetings and workshops were held in each one of them in order to get local scientists involved in this endeavor by contributing data and experience. Over 50 scientists participated. Most data were taken from top-level scientific literature or selected original contributions. Each single parameter of a seismogenic source has its own quality mark and the entire record is double checked for

internal consistency (e.g. size of the source vs. expected earthquake magnitude). Data uncertainties are handled by assigning a range of values to each parameter of a seismogenic source to capture its aleatoric variability. The probability of existence of the seismogenic source is also estimated according to a classification of the type of information that made the seismogenic known. Those seismogenic sources that did not pass a series of validity checks or remained controversially identified are stored in a dedicated layer of the database for future use. Also, alternative hypotheses and views about any specific seismogenic source are reported in commentaries, figures and references along with those that support it. Different proposals of seismogenic sources in overlapping area across regional boundaries were reconciled to ensure homogeneity of data collection. Critical parameters such as slip rates and maximum magnitude were also re-evaluated.

The regional databases and the collated and homogenized whole database are published in a dedicated website (<http://diss.rm.ingv.it/SHARE/>) along with other elaborations made to comply with different needs of other project tasks and work packages.

In addition to the regional database managers listed in Chapter 3, collaborators from INGV that contributed to this deliverable are:

Anna De Santis      *System manager*

Patrizio Petricca      *Subduction zones*

Gabriele Tarabusi      *Software programming and database maintenance*

Mara Monica Tiberti      *Subduction zones*

## 2. Basic definitions and database rationale

### 2.1. Seismogenic sources

A seismogenic source is a generalized, three-dimensional representation of a dipping surface in the earth's crust, where fault slip occurs and where most of the seismic energy is released during an earthquake. In most models, seismogenic sources are idealized as a uniformly dipping surface constrained between two horizontal lines that define the top edge and bottom edge of the source (Figure 1). The location of seismogenic sources are defined by pairs of latitude/longitude geographic coordinates in decimal degrees with positive values for North/East and negative values for South/West. Conventionally, seismogenic source models adopt the right-hand rule (Aki and Richards 1980) for representing the geometry of faults. As such, an observer walking along the upper edge of the source will always see the source surface on his/her right side; the direction the observer is facing (*i.e.*, the strike) is the angle formed clockwise from the geographic north.

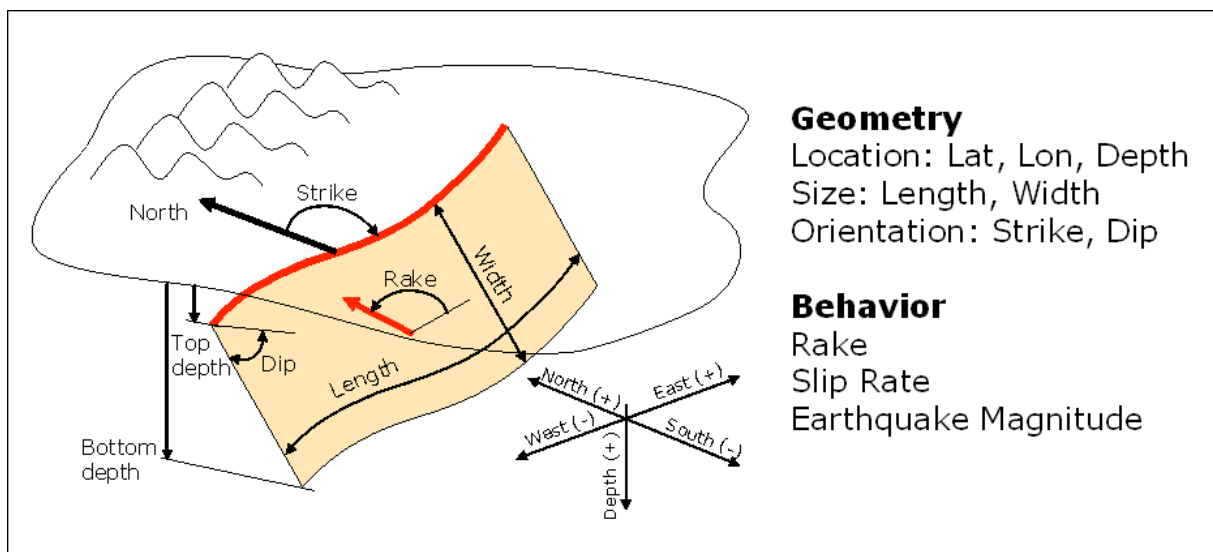

*Figure 1. Generalized three-dimensional representation of a seismogenic source as idealized in many models. Bold gray line is the top edge of the source and shaded dipping surface represents the seismogenic source. The bold black arrow on the fault surface represents the direction of slip.*

Additional characteristics such as length, strike, and width (as defined in structural geology textbooks) can be determined from the idealized geometry of the seismogenic source. Length is measured along strike from end to end of the seismogenic source. Width is the distance

between the two horizontal lines that constrain the dipping surface measured along dip. For vertical sources, the width equals the absolute value of the difference between upper and lower edges of seismogenic sources.

The behavior of a seismogenic source is typically defined by the sense of movement (rake), the amount of slip as a function of geologic time (slip rate) and the maximum earthquake magnitude it can generate. Geologic data are supposed to capture the mean behavior of a source.

Rake is a unit vector parallel to the fault surface whose direction is measured positive counter-clockwise from the direction parallel to the strike.

Most probabilistic seismic hazard assessments are typically based on slip rate or, less frequently, on the number of earthquakes during a specified interval of time, or recurrence rate. Analyses of field observations provide estimates of single event slip, cumulative (multi-event) slip, or both at a given location. Average single-event surface displacement usually underestimates slip at depth by a factor of about 1.32 (Wells and Coppersmith, 1994). Therefore, slip rate estimated at the surface generally underestimates the actual slip rate at depth. In addition, reported slip not only includes the sum of individual seismic events but also any aseismic slip on the fault. These components of slip are not distinguishable in the geologic record. The time component of slip rate also is associated with large uncertainties because geologic and paleoseismologic field data may span considerably different time frames ( $10^2$ - $10^6$  years). The time variability can be captured using, for example, logic-tree treatment of alternative slip rates.

Earthquake magnitude is measured in the moment-magnitude scale ( $M_w$ ) and represents the size of the largest earthquake that a seismogenic source can generate. Maximum earthquake magnitude can be directly determined using published empirical relations or be assigned using data independent from the mapped object, e.g. by using constraints like the largest historical earthquake that can be associated with that source or the largest fault segment that composes the source; as such, the largest potential earthquake will not necessarily rupture the entire source. This bears important consequences in applications that require individual fault ruptures; sources must be split into sections of appropriate dimension consistent with the assigned earthquake magnitude.

The SHARE database is designed to host three types of formalized seismogenic sources.

- The Individual Seismogenic Source (ISS) is a simplified representation of a fault plane that released, or is deemed to release in the future, a specific earthquake. This type of

source is thought to have "characteristic" behaviour with respect to rupture length/width and expected magnitude.

- The Composite Seismogenic Source (CSS) is a complex fault system containing an unspecified number of aligned seismogenic sources that cannot be singled out. This type of seismogenic source is not associated with a specific set of earthquakes or earthquake distribution but this association can be done a posteriori.
- The Debated Seismogenic Source (DSS) is an active fault that has been proposed in the literature as a potential seismogenic source but was not considered reliable enough to be included in any of the two types above.
- The Subduction source (SUBD) is a simplified representation of the plates interface at convergent boundaries. Similarly to CSS, a SUBD is not associated with a specific set of earthquakes or earthquake distribution but this association can be done a posteriori.

All of the above types of seismogenic sources are based on geological and geophysical data, although some of their parameters maybe defined based on some empirical or analytical relationship. More details about the first three types of seismogenic sources can be found in Basili et al. (2008 and 2009) and Haller and Basili (2011). The subduction sources are introduced in the database for the first time and will be better illustrated in Chapter 5.

## **2.2.Database structure**

The database of seismogenic sources is a geographically referenced relational database. Guidelines on how to compile records of the database and/or to reproduce the entire database structure (Basili et al., 2009) have been distributed at the WP3 Meeting on 14-16 September 2009 in Rome and made available from several websites.

The database is composed by several subsets which share the same structure and data model. Each subset covers a different region of the SHARE area. The subsets are first collated automatically into a single dataset and then scrutinized to produce and homogenized database (Figure 2). The latter procedure is illustrated in Chapter 4 in more details. This multi-level structure has the advantages of preserving the original data as they were supplied by the regional compilers and permits an easy update of the merged database when new data are added or old data reviewed.



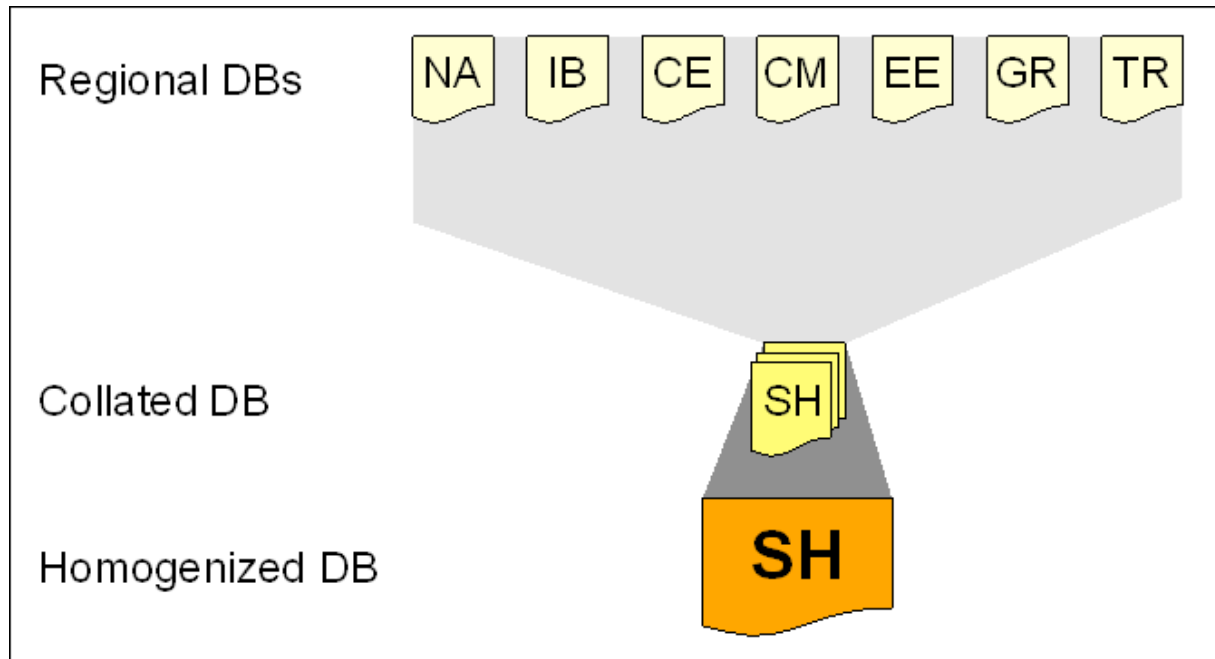

Figure 2. Database general scheme: NA, Northern Africa; IB, Iberia; CM, Central Mediterranean; CE, Central Europe; EE, Eastern Europe; GR, Greece; TR, Turkey; SH, SHARE.

We built a dedicated web site where the database is published and made available to the project partners. Figure 3 shows the database main page on the internet. Access to the database is provided through a Google-Earth “kml” module for map viewing where a link from the mapped object takes the users from the map window to a standard “html” display of fault parameters.

Common to the entire database are two tables where the information about the database compilers or data contributors (Table 1) and their affiliations (Table 2) are stored. These two relational tables are linked to the records in the tables of seismogenic sources through hierarchical codes. A *compiler* is the person who puts together the data about a seismogenic source and materially compiles the database record and makes the final decisions about the available data. A *contributor* is the person that provides data or original information or insights about a seismogenic source but does not participate in the making of the database record and thus is not supposed to endorse it.

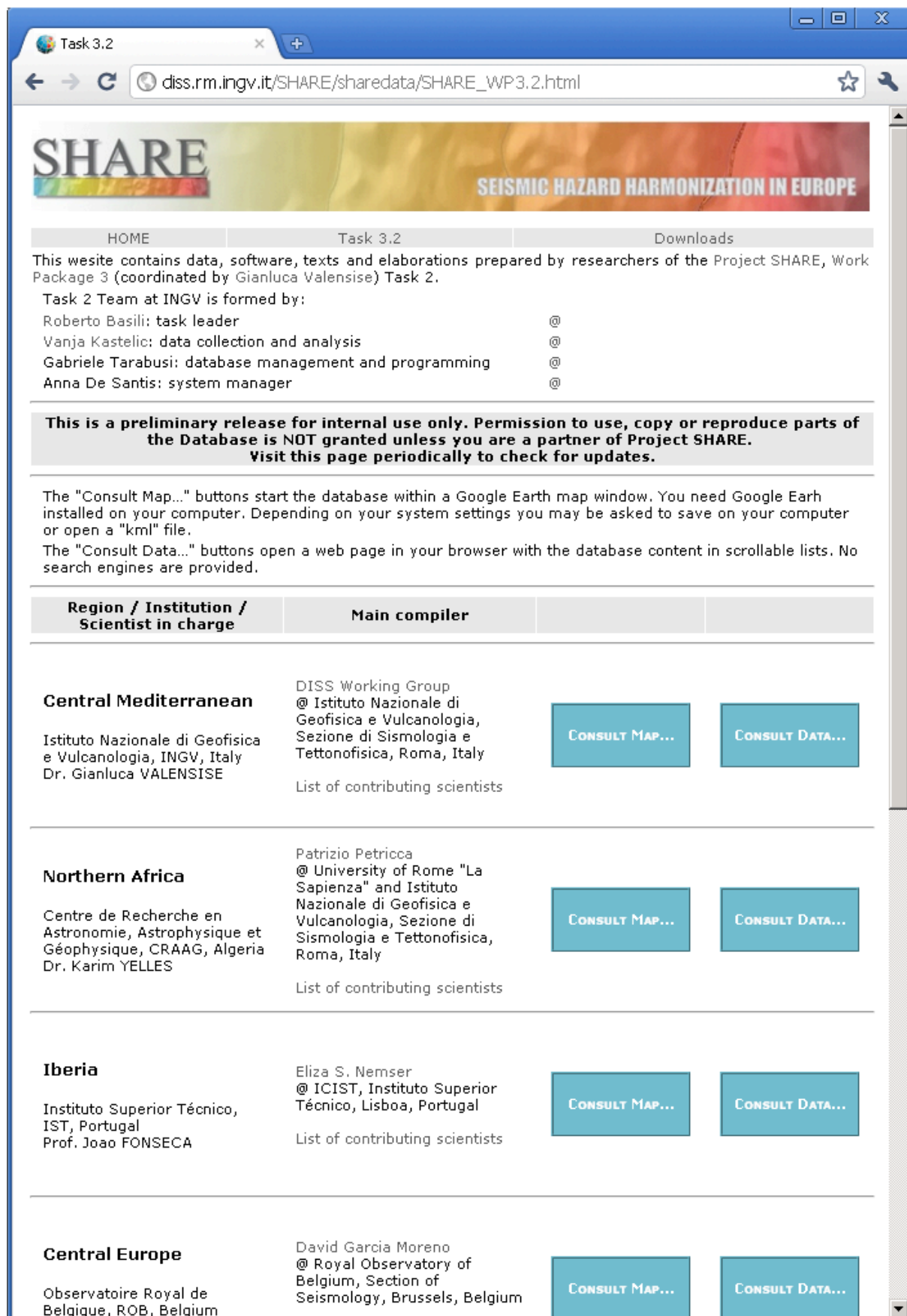

Figure 3. Screen shot of the database web site. Only the upper part of the data access page is shown.

Table 1. Compilers and contributors list table structure.

Field Name	Variable	Description
<b>IDContributor</b>	<i>Integer</i>	Ordinal number assigned to the contributor
<b>IDAffiliation</b>	<i>Integer</i>	Identifier of the contributor affiliation linking to AffiliationsList table
<b>Surname</b>	<i>Char(64)</i>	Full surname of the contributor
<b>Name</b>	<i>Char(64)</i>	Full name of the contributor or initial followed by dot
<b>MiddleName</b>	<i>Char(64)</i>	Full middle name of the contributor or initial(s), use dot between multiple initials.
<b>Email</b>	<i>Char(64)</i>	Personal e-mail address of the contributor
<b>Insert</b>	<i>Date</i>	When the record was first entered
<b>Update</b>	<i>Date</i>	When the record was last updated

Table 2. Compilers and contributors affiliation table structure.

Field Name	Variable	Description
<b>IDAffiliation</b>	<i>Integer</i>	Ordinal number assigned to any potential affiliation linked by ContributorsList table
<b>Name</b>	<i>Char(254)</i>	Full name of the institution
<b>Section</b>	<i>Char(254)</i>	Department or section name
<b>Address</b>	<i>Char(254)</i>	Postal address of the institution building
<b>Acronym</b>	<i>Char(16)</i>	Institution acronym
<b>Insert</b>	<i>Date</i>	When the record was first entered
<b>Update</b>	<i>Date</i>	When the record was last updated

Each record of the database represents a seismogenic source of one of the types illustrated in the previous section. Each seismogenic source is formed by a geographic feature and a set of alphanumeric attributes. All prescribed attributes are mandatory; no NULL values are accepted so that no exceptions have to be handled when using this database. Optional data include:

- additional geographic features (generally active faults or fold-axes traces as mapped at the ground surface) with attributes,
- a commentary,
- a set of pictures supplemented by a title and a caption, and
- a list of pertinent references.

These optional data are strongly recommended because they augment the characterization of the seismogenic source and support the decisions made when assembling the dataset. They will also facilitate future updates of the database.

To uniquely identify each database record we use a seven-character code with the following format

CCTT###

where

- CC is a two-character ISO 3166-1 code for names of officially recognized countries ([http://www.iso.org/iso/country\\_codes/iso\\_3166\\_code\\_lists.htm](http://www.iso.org/iso/country_codes/iso_3166_code_lists.htm));
- TT is a two-character code that identifies the type of data, either IS, CS, DS or SD for individual source, composite source, debated source or subduction, respectively.
- ### is an ordinal between 1 and 999 (including leading zeroes).

Table 3 illustrates in details an example of data table for seismogenic sources. The first part, General Information, is common to all types of seismogenic sources. The second part, Parametric Information, differs depending on the type of sources; that shown here is relative to CSS. The actual data tables contain many more fields where supplemental information is stored. These fields are omitted here for brevity because they are comprehensively illustrated in the database guidelines (Basili et al., 2009).

*Table 3 – Composite seismogenic source model parameters and definitions.*

<b>General Information</b>			
<b>Field name</b>	<b>Variable</b>	<b>Description</b>	
<b>IDSource</b>	<i>Char(7)</i>	The DISS-ID assigned to the record.	
<b>SourceName</b>	<i>Char(64)</i>	Seismogenic source name, taken from local geographical names based on the location of the source.	
<b>Compilers</b>	<i>Char(254)</i>	Code(s) of the compiler(s) of the record from field IDContributor of compilers and contributors relational table.	
<b>Contributors</b>	<i>Char(254)</i>	Code(s) of the contributor(s) of the record from field IDContributor of compilers and contributors relational table.	
<b>LatestUpdate</b>	<i>Date</i>	Date of the last update of the record.	
<b>Preferred</b>	<i>Logical</i>	Logical value used to indicate if the record complies with predefined requirements. It can be used for generating automated selections or controlling show/hide options of records.	
<b>Parametric Information</b>			
<b>Field name</b>	<b>Variable</b>	<b>Description</b>	<b>Units</b>
<b>MinDepth</b>	<i>Decimal(6, 1)</i>	Value of the minimum depth of the source, or depth of the upper edge, from sea level.	km

<b>MaxDepth</b>	<i>Decimal(6, 1)</i>	Value of the maximum depth of the source, or depth of the lower edge, from sea level.	km
<b>StrikeMin</b>	<i>Smallint</i>	Minimum value of the source direction, between $0-2\pi$ , clockwise from north following the right-hand rule (Aki and Richards 1980).	degrees
<b>StrikeMax</b>	<i>Smallint</i>	Maximum value of the source direction, between $0-2\pi$ , clockwise from north following the right hand rule.	degrees
<b>DipMin</b>	<i>Smallint</i>	Minimum value of the dip angle between $0-\pi/2$ from the horizontal.	degrees
<b>DipMax</b>	<i>Smallint</i>	Maximum value of the dip angle between $0-\pi/2$ from the horizontal.	degrees
<b>RakeMin</b>	<i>Smallint</i>	Minimum value of the hanging-wall sense of movement between $0-2\pi$ measured counterclockwise from the strike direction.	degrees
<b>RakeMax</b>	<i>Smallint</i>	Maximum value of the hanging-wall sense of movement between $0-2\pi$ measured counterclockwise from the strike direction.	degrees
<b>SlipRateMin</b>	<i>Decimal(7, 4)</i>	Minimum value of slip as a function of time.	mm/year
<b>SlipRateMax</b>	<i>Decimal(7, 4)</i>	Maximum value of slip as a function of time.	mm/year
<b>MaxMag</b>	<i>Decimal(3, 1)</i>	Maximum value of earthquake magnitude in the moment-magnitude scale ( $M_w$ ).	scalar

### 2.3.Data collection strategy

The EuroMediterranean area is very varied from the seismotectonic viewpoint. The plate boundary between Africa and Europe runs roughly west to east from the mid-Atlantic ridge to eastern Turkey with different mechanisms including continental collision, subduction, and transcurrence. Moving away from the plate boundary, the stable continental region is also locally rather active, as in the Pyrenees, the Rhine Graben, or the Eastern Alps. This variety of tectonic styles implies a need for local expertise to capture the essence of active faulting. Also, the local scientific literature is influenced by the different tectonic setting in addition to the local legacy. All these components of knowledge have been taken into account by eliciting local experts. The experts were informed about the nature and scope of the database and about the forms (compiler, contributor, reviewer) in which they could have participated in the construction of the database in dedicated formal meetings (Table 4) with extensive time

devoted to discussion. Actual data were then collected at follow-up sessions and through frequent email exchanges. All choices about the form of participation were honored. In addition to formal meetings, we also held a series of work sessions (Table 5) dedicated to refining the parameterization of seismogenic sources and the homogenization across regional boundaries.

*Table 4: Relevant SHARE meetings for developing the seismogenic sources database.*

<b>Title</b>	<b>Location and Date</b>
SHARE WP3 Meeting	<i>Rome, Italy, 14-16 September, 2009</i>
SHARE Regional Workshop for Iberia and northern Africa	<i>Olhão, Portugal, 14-16 January, 2010</i>
SHARE WP3 Meeting for Western and central Europe	<i>Brussels, Belgium, 19-20 January, 2010</i>
SHARE Regional Meeting for the Balkans and eastern Europe	<i>Podgorica, Montenegro, 7-9 March, 2010</i>
SHARE WP3 Regional Meeting for Greece and western Turkey	<i>Athens, Greece, 14-16 March, 2011</i>
SHARE First Annual Meeting	<i>Rome, Italy, 15-17 June, 2010</i>
SHARE Model Building Workshop	<i>Potsdam, Germany, 12-14 October, 2010</i>
IBERFAULT Meeting (co-sponsored)	<i>Sigüenza, Spain, 27-29 October, 2010</i>
SHARE-GEM Meeting	<i>Milano, Italy, 4 November, 2010</i>
EMME WP1-3 Meeting	<i>Istanbul, Turkey, 9-11 November, 2010</i>
GEM-SHARE-EMME-EMCA Joint Meeting	<i>Zurich, Switzerland, 1-3 February, 2011</i>
SHARE Workshop on Activity Rates	<i>Edinburgh, Great Britain, 28-29 March, 2011</i>
SHARE Model Building Workshop	<i>Zurich, Switzerland, 17-19 May, 2011</i>

*Table 5: Parameterization and homogenization work sessions.*

<b>Title</b>	<b>Location and Date</b>
Seismogenic Sources for the Iberia Region	<i>Sigüenza, Spain, 29 October 2010</i>
Seismogenic Sources for Turkey	<i>Istanbul, Turkey, 8 November, 2010</i>
Seismogenic Sources for Turkey and Greece	<i>Rome, Italy, 11-14 April, 2011</i>
Seismogenic Sources for Eastern Europe	<i>Podgorica, Montenegro, 9 May, 2011</i>
Seismogenic Sources between Eastern Europe and Central Mediterranean	<i>Rome, Italy, 12 May, 2011</i>

To test our strategy in collecting data and organizing the database we invited Kathleen M. Haller, who takes care of the USGS database of fault input data for the seismic hazard map of the US, the only other effort at a comparable scale of the SHARE database, to review our work at half-way through. Below is an excerpt of her recommendations following the First Annual Meeting, 15-17 June, 2010, Rome.

*“I appreciate your foresight to make sure that all contributors conform to uniform standards.”*

*“I agree with many of the discussions that you should develop a different data model for subduction zones instead of trying to make those sources conform to the data model developed to characterize crustal faults.”*

*“I highly recommend that you incorporate that principle [incorporating data from less certain sources in a seismic hazard model] in your dataset. ... The effective result of assigning a lower value for probability of activity is that the rate of activity is reduced and the fault’s local impact is reduced, not ignored as it would be if not included at all.”*

### 3. Regional databases of crustal seismogenic sources

This section illustrates the regional compilations of seismogenic sources. Table 6 summarizes the institutions involved in Task 3.2 and their correlative scientists in charge; the last column to the right lists the actual main compilers of the regional databases. Figure 4 shows the area covered by each regional database.

*Table 6. Regional database subdivision.*

<b>Region</b>	<b>Institution</b>	<b>Scientist in charge</b>	<b>Main compiler</b>
<b>Central Mediterranean</b>	INGV, Italy	G. Valensise	DISS Working Group INGV, Italy
<b>Northern Africa</b>	CRAAG, Algeria	K. Yelles	P. Petricca INGV, Italy
<b>Iberia</b>	IST, Portugal	J. Fonseca	E. S. Nemser IST, Portugal
<b>Central Europe</b>	ROB, Belgium	T. Camelbeeck	D. Garcia Moreno ROB, Belgium
<b>Eastern Europe</b>	MSO, Montenegro NIEP, Romania	B. Glavatovic M. Radulian	V. Kastelic INGV, Italy
<b>Greece</b>	NKUA, Greece AUTH, Greece	K. C. Makropoulos S. Pavlides	S. Sboras DST, University of Ferrara, Italy
<b>Turkey</b>	KOERI, Turkey	M. Erdik	M. B. Demircioglu KOERI, Turkey



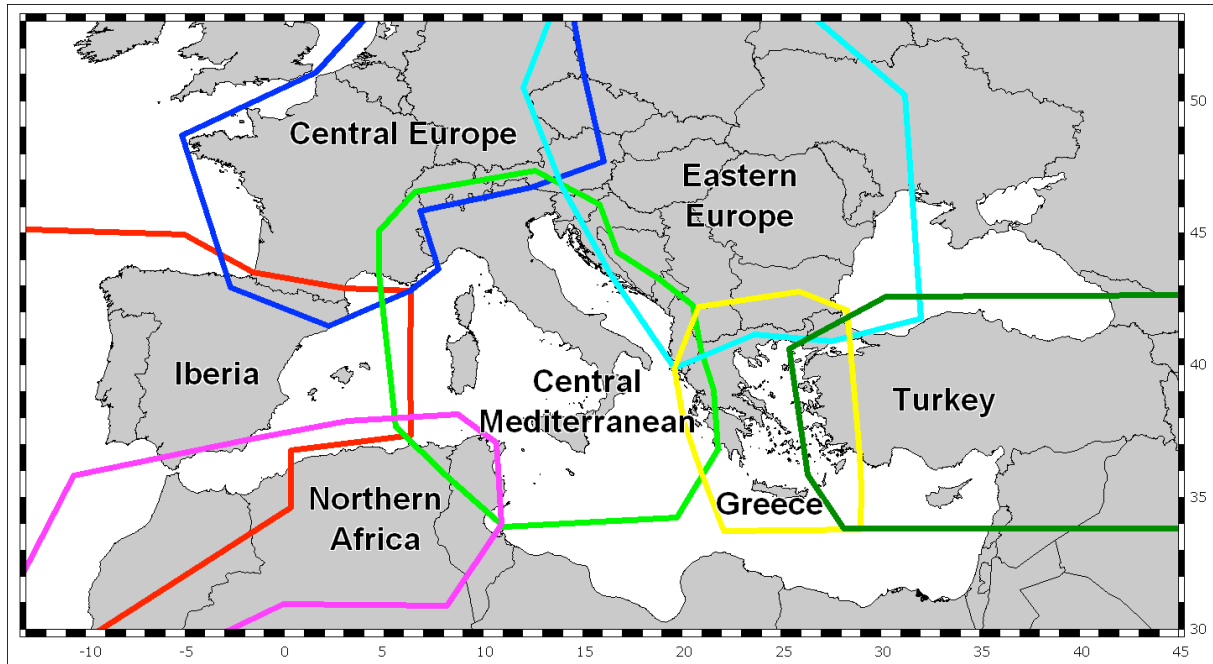

Figure 4. Map of the regional subdivision of the SHARE area for collecting data about seismogenic sources.

These regions cover different portions of the Africa-Eurasia plate boundary that runs from west of the Gibraltar Straits, with dominant strike-slip faulting, and carries on along northern Africa with contractional structures (mainly E-W fold and thrusts displaced by NE-SW tear faults). Across the Sicily channel, the plate boundary alternates from collision to subduction (Calabrian Arc) to collision again and then circles around the Adria microplate following the Apennines, the Alps, the Dinarides, the Albanides, and the Hellenides mountain chains up to the main Kefallonia-Lefkada strike-slip fault. East of the Kefallonia-Lefkada, the plate boundary splits into two branches. To the north it carries on with right-lateral strike-slip movement along the North Anatolian Fault and to the south follows the Hellenic and Cyprus subduction systems. West of Cyprus, the plate boundary changes again into strike-slip movement along the East Anatolian Fault and reconnects with the North Anatolian Fault in eastern Turkey. The main active zones, away from the plate boundary, are the Pyrenees (Iberia), the Rhine embayment (Central Europe), the inner Dinarides and the deep source of Vrancea (Eastern Europe).

## 4. Merged database of crustal seismogenic sources

This section illustrates how the regional databases were combined together into a single database and how the data were homogenized across regional boundaries.

As shown in Figure 2 and Chapter 3, the database of seismogenic sources is composed of seven regional databases. These databases were compiled by the regional database managers and were not subject to any treatment apart from technical assistance in making them conform to the adopted standards. An automated procedure generates a collated database which includes all regional databases and warns about potential conflicts (e.g. duplicated record identifiers) or inconsistencies (e.g. missing values). Subsequently, the collated database is scrutinized record by record by taking the following actions.

1. Filling-in missing data: this action implies searching through the literature associated to the source or making an educated judgment.
2. Checking fault's depth to the top with topographic elevation: this is particularly important in offshore areas.
3. Removing isolated (i.e. faults that cannot be combined together into a larger structure) faults shorter than 5 km or narrower than 3 km.
4. Removing faults that cut the entire crust and go through below the Moho without having been assigned the role of lithospheric structure (e.g. plate boundary).
5. Removing shallow faults with depth to the bottom of less than 3 km.
6. Removing or reconciling duplicated faults in overlapping areas across regional boundaries of data collection.

The above actions imply that removed records are not simply discarded but stored in the layer of debated seismogenic sources (DSS, see Chapter 2) for a second round of review by the regional database managers and compilers. Out of 998 records, 36 records were removed in version #1 of the merged database. In total, the merged database consists of about 66,000 km of fault sources, i.e. fully parameterized Composite Seismogenic Sources (Figure 5) as defined in Chapter 2. The database consists also of hundreds of ISS and tens of DSS.

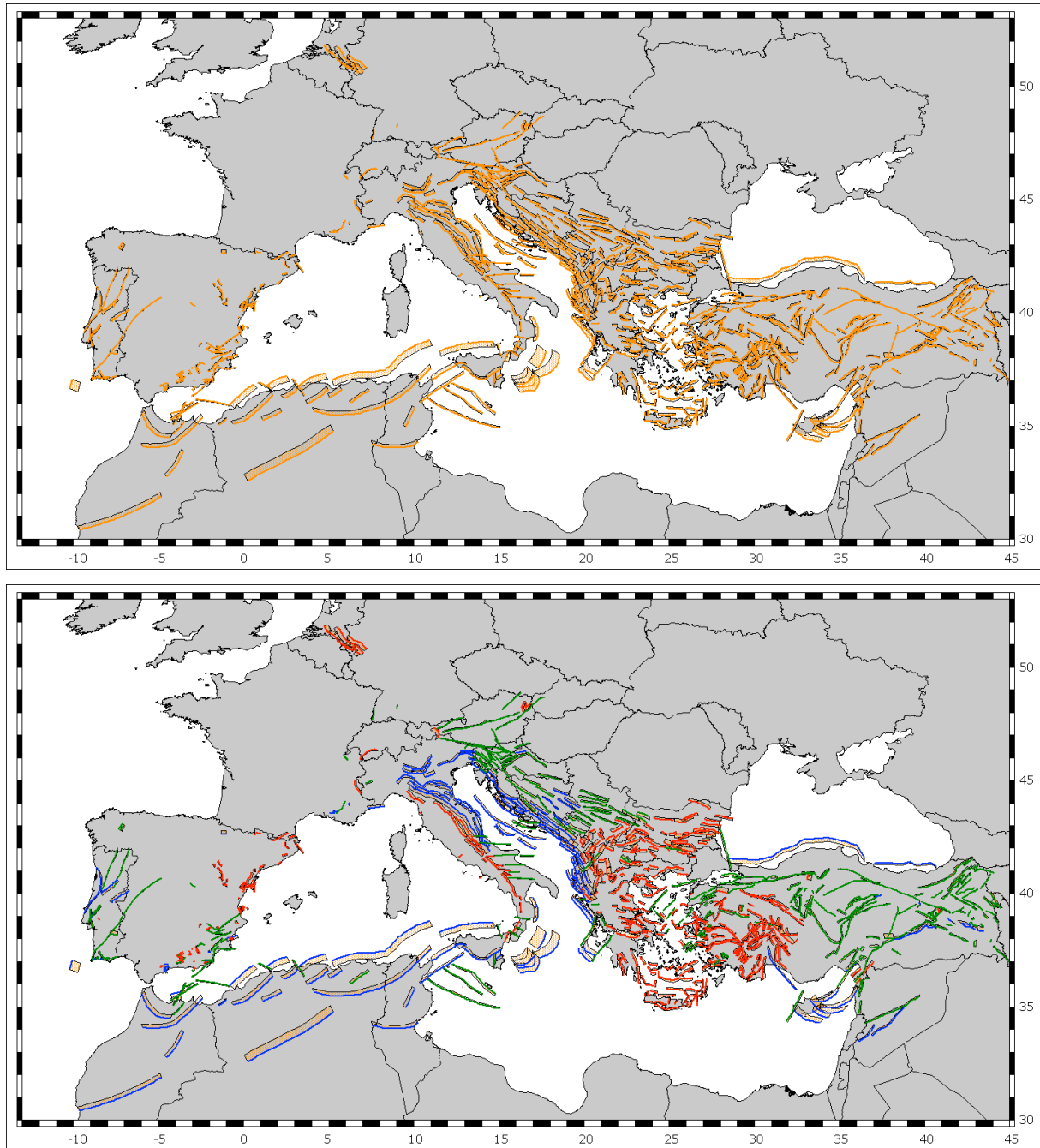

*Figure 5. Maps showing the Composite Seismogenic Sources of the merged database. In the lower panel seismogenic sources are color coded according to faulting mechanism: Red = normal; blue = reverse; green = strike slip and oblique slip.*

## 5. Subductions

To take into account the contribution of potential earthquakes generated by subduction sources we included in the database a new layer specifically designed during the course of the project. Subduction zones are known to generate earthquake ruptures of several types: those generated at the slab interface, those generated within the slab (intra-slab and outer-rise), and those that propagate from the slab interface into the upper plate (megaseisms) (Satake and Tanioka, 1999) and to follow different scaling laws (Strasser et al., 2010) and rheology (Bilek and Lay, 1999) from those of crustal earthquakes. Since this layer was not included in previous schemes, it was partially inspired at existing models available in the literature, such as the SLAB 1.0 by Hayes and Wald (2009) and Hayes et al. (2009).

The subduction layer is designed as to include a model of the plates interface at convergent boundaries based on geological and geophysical data. The plate interface is mapped as collection of free-form polygons with a variable number of nodes. Each single polygon, or sub-element, represents a portion of the entire surface of the subducting plate from the outer limit of the trench to the lower tip of the dipping slab (Figure 6). Notice that this scheme includes portions of the slab at depths that probably exceed those useful for hazard assessment. However, this condition has to be determined a posteriori. In addition, some modeling techniques (e.g. finite elements) could benefit from the availability of data about the whole subduction. Each sub-element has consistent geologic, geometric and kinematic characteristics and is bounded by lines of constant depth except for the uppermost line when it coincides with the seafloor.

Similarly to crustal seismogenic sources, subductions are characterized by geometric (strike, dip, depth, crust thickness) and behavior (rake, slip rate, seismic coupling, maximum earthquake magnitude) parameters. These parameters are given for all sub-elements and their range of variability within the entire subduction is also stored in a summary table.

Differently from crustal seismogenic sources, some parameters have a peculiar role. Seismic coupling, although very difficult to estimate, is supposed to provide a ratio between plate convergence and earthquake production at the slab interface. Two earthquake magnitude parameters are supplied which capture the maximum observed magnitude produced at the slab interface and within the slab. Also, in the subduction table NULL values are allowed. This condition is made acceptable because various parameters may not be applicable in every sub-element that makes up a subduction record, e.g. in the deeper portion of the slab or in case of slab windows. Table 7 illustrates the specific attributes of sub-elements of subduction sources.

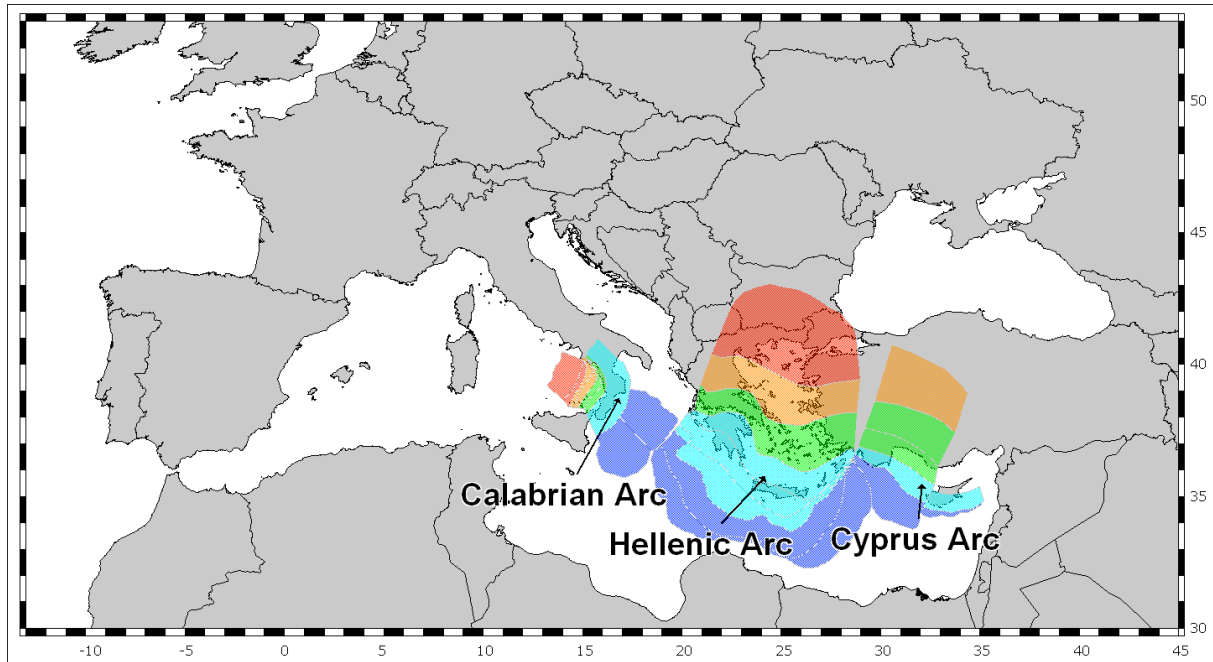

Figure 6. Map showing the main subduction zones. Color coding according to depth: blue = 0-10 km, light blue = 10-50 km, lime green = 50-200 km, orange = 200-300 km, red >300 km.

Geological and geophysical data used for estimating the values of parameters include interpreted seismic profiles, gravity and tomography data, receiver function Moho depth determinations and earthquake focal mechanisms and hypocenter determinations.

Table 7. Subduction sub-element attributes definition.

**General Information**

Field name	Variable	Description
<b>IDSource</b>	<i>Char(7)</i>	ID assigned to the record.
<b>SourceName</b>	<i>Char(64)</i>	Subduction system name.
<b>ID</b>	<i>Integer</i>	Ordinal value that identifies the subelement of the subduction.
<b>Type</b>	<i>Char(64)</i>	Description of the subelement with respect to the subduction system (e.g. Base of the accretionary wedge, Hinge, Dipping slab)
<b>Compilers</b>	<i>Char(254)</i>	Code(s) of the compiler(s) of the record from field IDContributor of compilers and contributors relational table.
<b>Contributors</b>	<i>Char(254)</i>	Code(s) of the contributor(s) of the record from field IDContributor of compilers and contributors relational table.
<b>LatestUpdate</b>	<i>Date</i>	Date of the last update of the record.

**Preferred** *Logical* Logical value used to indicate if the record complies with predefined requirements. It can be used for generating automated selections or controlling show/hide options of records.

<b>Parametric Information</b>			
<b>Field name</b>	<b>Variable</b>	<b>Description</b>	<b>Units</b>
<b>MinDepth</b>	<i>Decimal(6,1)</i>	Depth of the sub-element upper edge from sea level.	km
<b>MaxDepth</b>	<i>Decimal(6,1)</i>	Depth of the sub-element lower edge from sea level.	km
<b>CrustThicknessMin</b>	<i>Decimal(6,1)</i>	Minimum value of the subducting plate thickness of the crust in the sub-element.	km
<b>CrustThicknessMax</b>	<i>Decimal(6,1)</i>	Maximum value of the subducting plate thickness of the crust in the sub-element.	km
<b>StrikeMin</b>	<i>Smallint</i>	Value of the minimum sub-element direction (between 0 and $2\pi$ ) clockwise from North following the right hand rule.	degrees
<b>StrikeMax</b>	<i>Smallint</i>	Value of the maximum sub-element direction (between 0 and $2\pi$ ) clockwise from North following the right hand rule.	degrees
<b>DipMin</b>	<i>Smallint</i>	Value of the minimum dip angle (between 0 and $\pi/2$ ) from the horizontal.	degrees
<b>DipMax</b>	<i>Smallint</i>	Value of the maximum dip angle (between 0 and $\pi/2$ ) from the horizontal.	degrees
<b>RakeMin</b>	<i>Smallint</i>	Minimum value of the hanging-wall sense of movement (between 0 and $2\pi$ ), measured counterclockwise from the strike direction.	degrees
<b>RakeMax</b>	<i>Smallint</i>	Maximum value of the hanging-wall sense of movement (between 0 and $2\pi$ ), measured counterclockwise from the strike direction.	degrees
<b>SlipRateMin</b>	<i>Decimal(7,4)</i>	<i>Minimum value of slip as a function of time.</i>	mm/year
<b>SlipRateMax</b>	<i>Decimal(7,4)</i>	<i>Maximum value of slip as a function of time.</i>	mm/year
<b>SeismicCoupling</b>	<i>Decimal(5,2)</i>	<i>Seismic/aseismic factor (between 0-1) that indicates how much slip rate can be converted into seismic activity.</i>	Scalar
<b>MaxMagnitudeIF</b>	<i>Decimal(3,1)</i>	Value of the maximum observed magnitude in the moment magnitude scale (Mw) of interface earthquakes of the sub-element.	Scalar
<b>MaxMagnitudeIS</b>	<i>Decimal(3,1)</i>	Value of the maximum observed magnitude in the moment magnitude scale (Mw) of intraslab earthquakes of the sub-element.	Scalar

## 6. From the database to the actual input data

In previous sections we illustrated the main characteristics of the database of seismogenic sources specifically designed to serve seismic hazard assessment. However, the database is only a repository of basic geological and geophysical data as supplied by the compilers. In order to be effectively used, these data need additional treatments to make them comply with the specific needs of the hazard engine in use. These additional treatments include the following.

- Estimating homogeneous maximum earthquake magnitudes for fault sources.
- Addressing the basic epistemic uncertainty of fault sources existence (or likelihood of fault activity in producing earthquakes).
- Designing background zones around fault sources to calculate seismicity parameters to be used in assessing fault activity rates.

To provide a more robust and homogeneous estimation of the largest earthquake size that a fault source can generate we designed a relational table which includes a distribution of maximum magnitudes obtained from a variety of the most common scaling laws in the moment magnitude scale ( $M_w$ ). This distribution includes the value provided by the compiler(s). The used scaling laws are listed below.

- Wells and Coppersmith (1994), [WC94]; provide a set of empirical equations appropriate for active regions.
- Mai and Beroza (2000), [MB00]; provide a set of equations from finite rupture models.
- Leonard (2010), [LE10]; provides different parameterizations for stable continental regions and active regions.
- Hanks and Bakun (2002), [HB02]; provide equations specifically derived for strike-slip faulting.

When recalculating magnitude values (Figure 7) the procedure takes care of selecting the appropriate fault parameter to be used and of honoring its range of validity. A simple statistics of the distribution is also provided. The actual values to be used in calculations have to be agreed upon with Task 3.5.

To handle the epistemic uncertainty of fault sources we developed a scheme to classify a fault's ability to generating earthquakes. Similar schemes have already been proposed in other seismic hazard efforts (e.g. SSHAC, 1997).

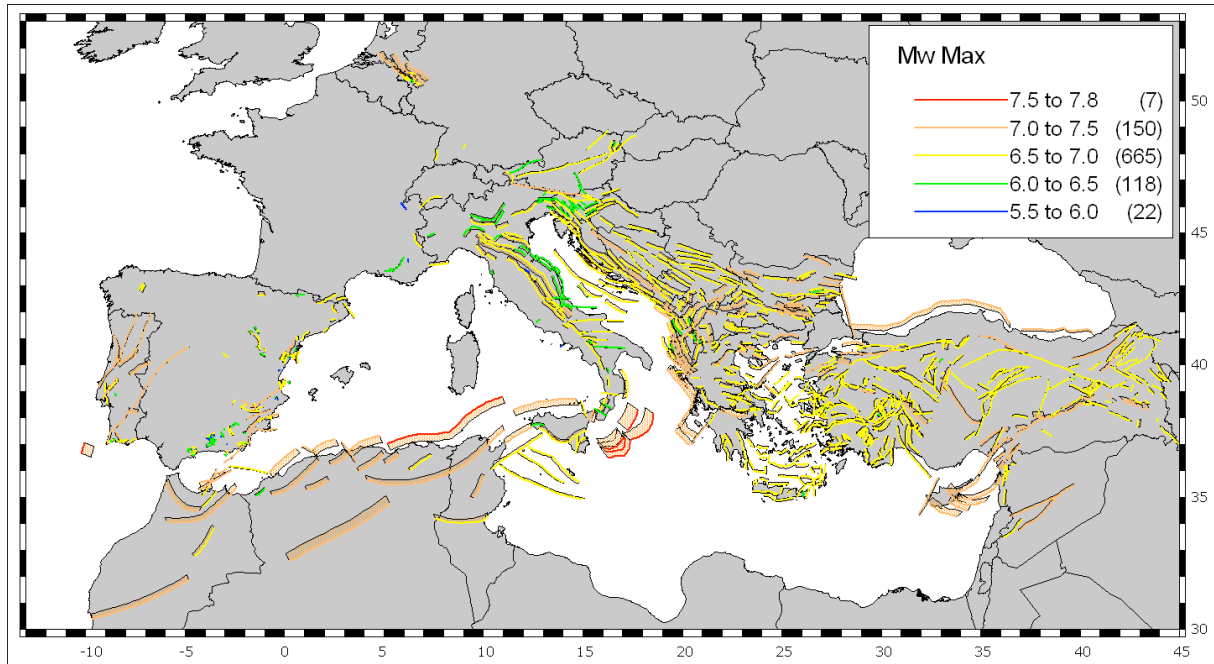

Figure 7. Map showing a sample output of the procedure that recalculates magnitudes.

The existence of a seismogenic source can be declared on the basis of one of the following propositions:

One knows that a fault exists because it generated...

- (1) ... an earthquake known from instrumental recordings;
- (2) ... an earthquake known from historical accounts;
- (3) ... a pre-historical earthquake known for its paleoseismological evidence (e.g.: surface rupture, seismites, liquefaction, tsunami deposits);
- (4) ... no earthquake but the fault belongs to a fault system in which at least one neighboring fault is classified as case (1), (2) or (3);
- (5) ... no earthquake but the fault belongs to a system that is thought to be active;
- (6) ... no earthquake but there is some evidence that the fault would do so.

The quality level decreases from case (1) to (6). To each case we can assign a progressively lower score in the range 1 – 0. These values have to be agreed upon with other Tasks (especially Task 3.1) of the Work Package and with WP5.

The fault sources background zones have been designed for calculating activity rates together with seismicity and avoiding double counting of earthquakes. Each zone in the map has a set of attributes illustrated in details in Table 8. The values in this table can be recalculated easily each time the map is updated depending on the needs and input from other Tasks and Workpackages.



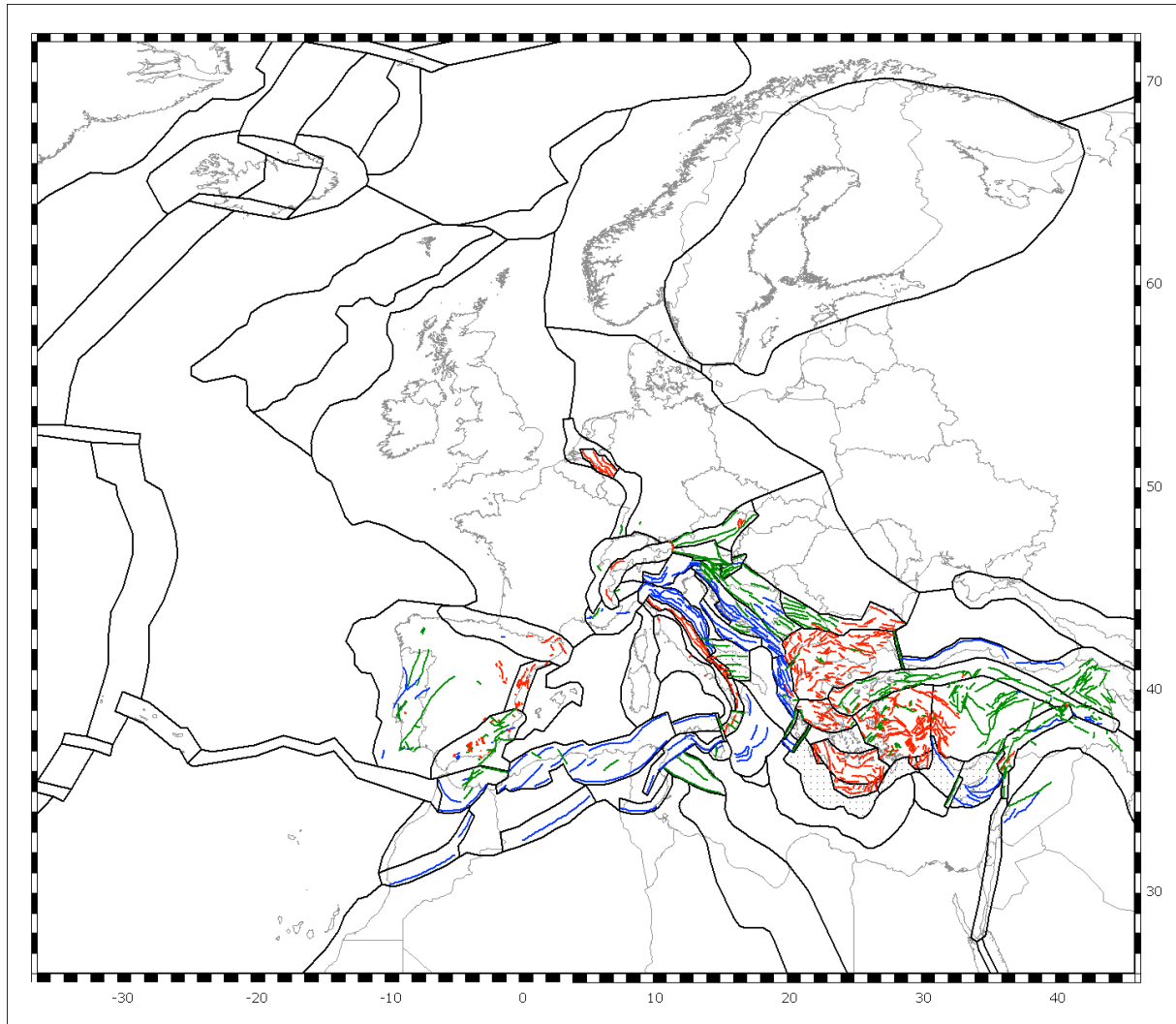

Figure 8. Map showing the fault sources background zones. Fault color codes as in Figure 5.

Table 8. Fault sources background zones attributes definition.

Field name	Variable	Description	Units
<b>ID</b>	<i>Integer</i>	Ordinal, identifier of the zone	N/A
<b>Name</b>	<i>Char(32)</i>	Text string, name of the zone	N/A
<b>Type</b>	<i>Char(16)</i>	Text string, type of the zone based on faults or tectonics	N/A
<b>FM</b>	<i>Char(16)</i>	Text string, style of faulting based on focal mechanisms	N/A
<b>R</b>	<i>Integer</i>	Percentage of reverse faulting	%
<b>S</b>	<i>Integer</i>	Percentage of strike-slip faulting	%
<b>N</b>	<i>Integer</i>	Percentage of normal faulting	%
<b>NDataTot</b>	<i>Integer</i>	Number of data used for determining R, S, N	Scalar

$R_i$ ,  $S_i$ ,  $N_i$ ,  $NDataToti$  for  $i = 1-4$ : same field as above relative to the four different databases of stress data and faulting mechanisms.

<b>Area</b>	<i>Float</i>	Area of the zone	km <sup>2</sup>
<b>Elevation</b>	<i>Float</i>	Average elevation of the zone	m
<b>DepthUC</b>	<i>Float</i>	Depth of the Upper Crust	km
<b>DepthMC</b>	<i>Float</i>	Depth of the Middle Crust	km
<b>DepthLC</b>	<i>Float</i>	Depth of the Lower Crust	km
<b>MuUC</b>	<i>Float</i>	Rigidity of the Upper Crust	GPa
<b>MuMC</b>	<i>Float</i>	Rigidity of the Middle Crust	GPa
<b>MuLC</b>	<i>Float</i>	Rigidity of the Lower Crust in	GPa
<b>FaultMinDepth</b>	<i>Float</i>	Minimum depth (km) to the top of faults within the zone	km
<b>FaultMaxDepth</b>	<i>Float</i>	Maximum depth (km) to the bottom of faults within the zone	km
<b>FaultMaxMag</b>	<i>Float</i>	Maximum magnitude (Mw) of faults within the zone	Scalar
<b>NFault</b>	<i>Integer</i>	Number of faults within the zone	Scalar
<b>MORateMin</b>	<i>Float</i>	Seismic moment rate (min) from all faults within the zone	Nm
<b>MORateMax</b>	<i>Float</i>	Seismic moment rate (max) from all faults within the zone	Nm
<b>MORateAvg</b>	<i>Float</i>	Seismic moment rate (avg) from all faults within the zone	Nm

The field “Type” is assigned based on the style of faulting in actual seismogenic sources included in the zone or on regional tectonics. The field “FM” (for focal mechanism) is instead the style of faulting as results of the analysis of four databases of stress data and focal mechanisms. Style of faulting is determined according to a simplification, from five to three categories, of the method proposed by Zoback (1992). The databases used are the World Stress Map (Heidbach et al., 2008), EMMA (Vannucci and Gasperini, 2004), CMT catalog (Ekström and Nettles, 2010), RCMT catalog (Pondrelli et al., 2011 and references therein).

Crustal depths and rigidity are based on data from and the 2x2 deg tiles of the CRUST 2.0 model (Laske et al., 2010). Rigidity (GPa) is calculated as  $\mu = \rho\beta^2$ , where  $\rho$  is density, and  $\beta$  is S-wave velocity (Lay and Wallace, 1995).

The last seven fields are derived directly from the fault sources in the homogenized version of the database of seismogenic sources. Seismic moment rate is calculated as  $M_0^* = \mu L W \dot{D}$ , where  $\mu$  is rigidity,  $L$  is fault total length,  $W$  is fault width,  $\dot{D}$  is slip rate.

## 7. References

- Aki, K., P. G. Richards (1980). *Quantitative Seismology, Theory and Methods*, vol. I, 557 pps. San Francisco: W.H. Freeman and Company.
- Basili R., G. Valensise, P. Vannoli, P. Burrato, U. Fracassi, S. Mariano, M.M. Tiberti, E. Boschi (2008), *The Database of Individual Seismogenic Sources (DISS)*, version 3: summarizing 20 years of research on Italy's earthquake geology, *Tectonophysics*, doi:10.1016/j.tecto.2007.04.014.
- Basili, R., Kastelic, V., Valensise, G., and DISS Working Group 2009 (2009), *DISS3 tutorial series: Guidelines for compiling records of the Database of Individual Seismogenic Sources*, version 3. *Rapporti Tecnici INGV*, no. 108, 20 p., <http://portale.ingv.it/produzione-scientifica/rapporti-tecnici-ingv/archivio/rapporti-tecnici-2009/>.
- Bilek, S. L., and T. Lay (1999). Rigidity variations with depth along interplate megathrust faults in subduction zones. *Nature* 400, 443-446, doi:10.1038/22739
- Ekström, G., and M. Nettles (Overseers), 2010, *Global Centroid Moment Tensor Catalog*, <http://www.globalcmt.org/>
- Haller, K. M., and R. Basili (2011). Developing Seismogenic Source Models Based on Geologic Fault Data. *Seismological Research Letters*, 82(4), 515-521, doi: 10.1785/gssrl.82.4.515.
- Hanks, T. C., and W. H. Bakun (2002). A bilinear source-scaling model for  $M$ -log  $A$  observations of continental earthquakes. *Bulletin of the Seismological Society of America* 92, 1841-1846.
- Hayes, G. P. and D. J. Wald (2009). Developing framework to constrain the geometry of the seismic rupture plane on subduction interfaces a priori- a probabilistic approach. *Geophys. J. Int.*, 176, 3, 951-964, 10.1111/j.1365-246X.2008.04035.x.
- Hayes, G. P., D. J. Wald and K. Keranen (2009). Advancing techniques to constrain the geometry of the seismic rupture plane on subduction interfaces a priori: Higher-order functional fits. *Geochem. Geophys. Geosyst.*, 10, 9, Q09006, 10.1029/2009GC002633.
- Heidbach, O., Tingay, M., Barth, A., Reinecker, J., Kurfes, D. and Müller, B., *The World Stress Map database release 2008* doi:10.1594/GFZ.WSM.Rel2008, 2008. (<http://dc-app3-14.gfz-potsdam.de>)
- Laske G., Masters G., and Reif G., (2010). *CRUST 2.0: A New Global Crustal Model at 2x2 Degrees*. (Last update September 06, 2010; <http://igppweb.ucsd.edu/~gabi/rem.html>).
- Lay T. and Wallace T.C. (1995). *Modern global seismology*, Volume 58 of *International geophysics series*, p. 521. San Diego: Academic Press.
- Leonard M. (2010). Earthquake Fault Scaling: Self-Consistent Relating of Rupture Length, Width, Average Displacement, and Moment Release. *Bulletin of the Seismological Society of America*, 100 (5A), 1971-1988, doi: 10.1785/0120090189
- Mai, P. M., and G. C. Beroza (2000). Source Scaling Properties from Finite-Fault-Rupture Models. *Bulletin of the Seismological Society of America*, 90 (3), 604-615.
- Petersen, M. D., A. D. Frankel, S. C. Harmsen, C. S. Mueller, K. M. Haller, R. L. Wheeler, R. L. Wesson, Y. Zeng, O. S. Boyd, D. M. Perkins, N. Luco, E. H. Field, C. J. Wills and K.

- S. Rukstales (2008). Documentation for the 2008 Update of the United States National Seismic Hazard Maps, U.S. Geological Survey Open-File Report 2008–1128, 61 p.
- Pondrelli S., Salimbeni S., Morelli A., Ekström G., Postpischl L., Vannucci G. and Boschi E., (2011). European-Mediterranean Regional Centroid Moment Tensor Catalog: solutions for 2005-2008, *Phys. Earth Planet. Int.*, in press.
- Satake, K. and Y. Tanioka (1999). Sources of Tsunami and Tsunamigenic Earthquakes in Subduction Zones. *Pure Appl. Geophys.*, 154, 3, 467-483, 10.1007/s000240050240.
- Senior Seismic Hazard Analysis Committee (SSHAC), R. J. Budnitz (chair), G. Apostolakis, D. M. Boore, L. S. Cluff, K. J. Coppersmith, C. A. Cornell, and P. A. Morris (1997). Recommendations for Probabilistic Seismic Hazard Analysis. Guidance on Uncertainties and Use of Experts. Report NUREG/CR-6372, in 2 volumes, Washington, D.C., U.S. Nuclear Regulatory Commission.
- Stirling, M. W., G. H. McVerry, and K. R. Berryman (2002). A New Seismic Hazard Model for New Zealand. *Bulletin of the Seismological Society of America*, 92(5), 1878-1903.
- Strasser, F. O., M. C. Arango and J. J. Bommer (2010). Scaling of the Source Dimensions of Interface and Intraslab Subduction-zone Earthquakes with Moment Magnitude. *Seismol. Res. Lett.*, 81, 6, 941-950, 10.1785/gssrl.81.6.941.
- Vannucci, G., Gasperini, P., 2004. The new release of the database of Earthquake Mechanisms of the Mediterranean Area (EMMA Version 2). *Ann. Geophys.* 47(1) (Suppl. 1), 307–334.
- Wells, D. L., and K. J. Coppersmith (1994). New empirical relationships among magnitude, rupture length, rupture width, and surface displacements. *Bulletin of the Seismological Society of America* 84, 974–1002.
- Zoback, M.L. (1992). First- and second-order patterns of stress in the lithosphere: The World Stress Map project. *J. Geophys. Res.*, 97, 11,703-11,728, doi:10.1029/92JB00132.